

Shower Waste Instructions

90 mm Shower Trap C/W Key Installation & Assembly Instructions

A. Trap Assembly

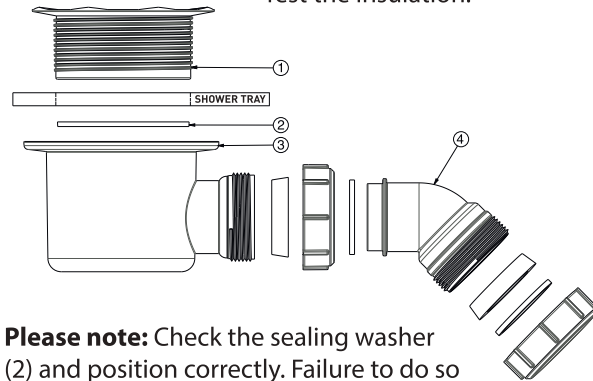
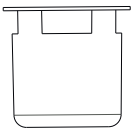
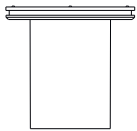

This trap provides a flow rate greater than 32L per minute when tested in accordance with EN274-2:2002. The flow rate can be adversely affected if an adequate fall is not maintained throughout the length of the waste pipe.

Install the trap into the shower tray by assembling 1,2,3,4 as shown. Connect the trap outlet 4 to the waste pipe making sure the pipe is supported. Test the insulation.

Please note: Check the sealing washer (2) and position correctly. Failure to do so may result in leaks.



B. Trap Fitting

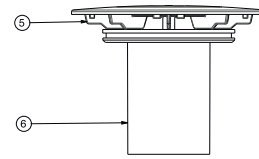

Insert the container and trap (6-7) firmly engage the trap in the bottom position

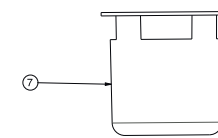

Note: If silicone sealant is used, do not use an acetoc sealant

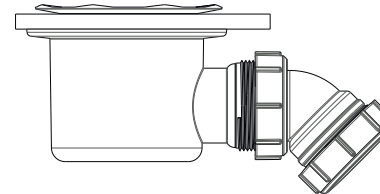

C. Completed Assembly

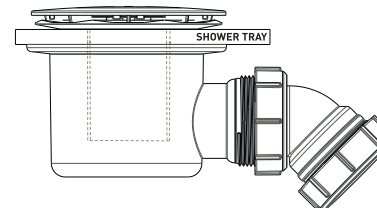

After Care: Regular maintenance is required to retain a high flow rate. Remove the flange (5) and trap assembly (6-7) and thoroughly clean all the parts. Rinse through the trap body with clean water and carefully reassemble the parts.

MH-01

Warning: Do not use abrasives, scourers, bleach or any type of chemical cleaning solution when cleaning the waste cap. Soapy water only should be used.